

ARIZE

3D LASER FOOT SCANNER
MODEL 28BA0101

3D Laser Foot Scanner



Installation and User Guide

Date of last revision: 2021-06-18 Version 5.

Original instructions according to European Directive 2006/42/EC

© Copyright 2020 HP Development Company, L.P. Edition 1 June 25, 2020 Legal notices. The information contained herein is subject to change without notice. The only warranties for HP products and services are set forth in the express warranty statement accompanying such products and services. Nothing herein should be construed as constituting an additional warranty. HP shall not be liable for technical or editorial errors or omissions contained herein.

Information in this guide is subject to change without notice.

No part of this document may be reproduced or transmitted in any way without the express written permission of HP Inc.

TABLE OF CONTENTS

1. INTRODUCTION	5
1.1 About this guide	5
1.2 Manufacturer contact information	5
1.3 Product description	6
1.4 Product overview	7
1.4.1. Model 28BA0101	8
2. GENERAL INFORMATION	9
2.1 Symbols	9
2.2 Intended Use	10
2.3 Contraindications	10
2.4 System requirements	10
2.5 General safety information	10
2.6 Laser safety	11
2.7 Safety inspections	11
2.8. Care of the 3D Laser Foot Scanner	11
2.9. Calibration and repair	11
2.10 Limited warranty terms and conditions	12
3. UNPACKING AND INSTALLATION	13
4. SOFTWARE INSTALLATION	15
5. CONNECTING THE SCANNER	16
6. START THE SOFTWARE	17
7. YOUR FIRST MEASUREMENT	17
8. TROUBLESHOOTING	18
9. SYSTEM SPECIFICATIONS	19
9.1. Model 28BA0101	19

1. INTRODUCTION

1.1 About this guide

Congratulations on your new purchase. The 3D Laser Foot Scanner is intended to obtain foot dimensions and images.

This guide will assist you with the installation and usage of the 3D Laser Foot Scanner model 28BA0101. The installation consists of:

- ✓ Unpacking& installation
- ✓ Connecting the scanner
- ✓ Initial settings
- ✓ Your first measurement

Enjoy your 3D Laser Foot Scanner.

1.2 Manufacturer contact information

HP Inc.
1501 Page Mill Road
Palo Alto, CA 94304
Tel. +1 650 857 1501



Website
ArizeClinical.com



Support
arize@edserlabs.com

1.3 Product description

The 3D Laser Foot Scanner uses laser triangulation technology combined with 2D color images for a precise 3D representation of the feet.

Eight monochrome cameras are used for the 3D image, one color camera for the texture, and four lasers. This allows precise and fast scans of feet in normal ambient light conditions.



Each of the four lasers projects a line onto the foot from several angles. The eight monochrome cameras capture the laser projections.

The lasers and cameras are mounted on a moving carriage. When the foot is scanned and the carriage moves back to the home position, the backlight LED is turned on and a 2D color image of the sole of the foot is scanned.

Geometric algorithms are used to measure and digitize the surface. The processing of the 3D and 2D images, calculations, measurements and interpretation of the results is done by the software package on the connected PC.

The center of the active scanning area is marked on the glass plate with three white markers shown where arrows are pointing.

*Top View of Scanner:

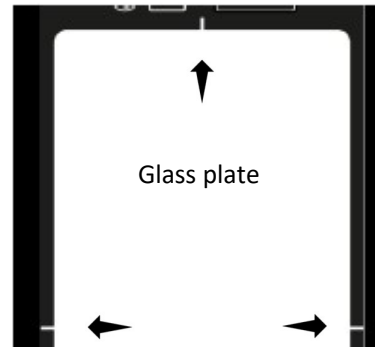

1.4 Product overview

1.4.1. Model 28BA0101

The 3D Laser Foot Scanner model 28BA0101 package includes:

- 3D Laser Foot Scanner.

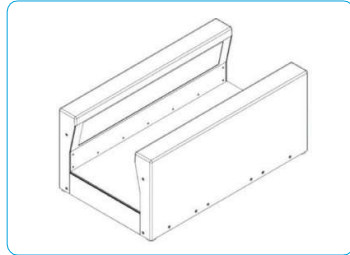

- Power cord with a C13 plug, the other side will be country specific.



- USB cable A-B 1.8m (71 Inches).
Do not use any other USB cable!



- This guide.



- AC adapter.
Brand: Delta Electronics inc.
Model: MDS-060AAS19-B
Do not use any other AC adapter!



- Two Lifting straps.

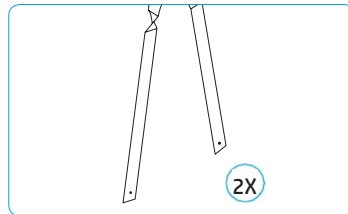

- Allen key (attached to a lifting strap).

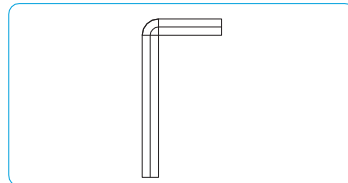

1.4 Product overview

1.4.1. Model 28BA0101

The accessories package includes:

- Handlebar and two extension rods.

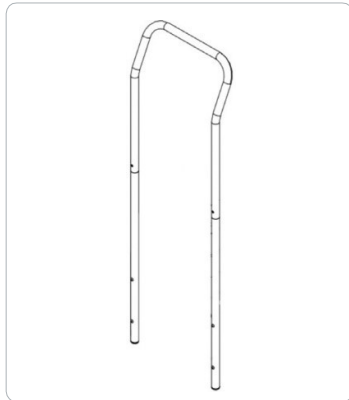

- Four knob screws to mount the support steps to the scanner.

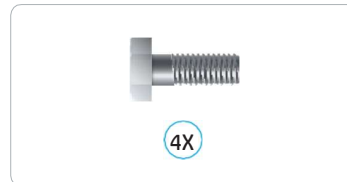

- Two support steps.

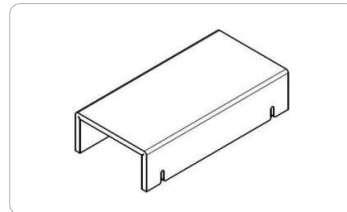















- Four screws to mount the handlebar to the scanner.



2. GENERAL INFORMATION

2.1. Symbols

The following symbols may appear on the product, packaging or documentation:

-  **Caution, read these instructions carefully.**
If used on the product label: Caution, consult accompanying documentation.
-  Regulatory Mark for the European Directive 2002/96/EC on Waste Electrical and Electronic Equipment (WEEE).
-  Serial Number
-  Manufacturer
-  Type B applied part, the entire 3D foot scanner is designated as Type B applied part
-  CE mark according to European Directives
-  Power
-  Power off
-  Power on
-  DC power
-  USB port
-  Do not jump on the glass plate, or tread lightly
-  Do not exceed the maximum weight limit of 200Kg (440 lbs)
-  Class 1 laser product as per IEC 60825-1:2014 (Third Edition)
-  This way up
-  Fragile, handle with care
-  Keep dry
-  Temperature limitation
-  Humidity limitation
-  Atmospheric pressure limitation
-  Refer to instruction manual
-  Recyclable packaging.

2.2 Intended Use

The 3D Foot Scanner is intended for human beings to obtain a 3D foot model with dimensional parameters for general, clinical, or scientific use. Operation and interpretation of the measurements should be done by trained professionals.

2.3 Contraindications

Clients with stability issues might require assistance during the measurement.

2.4 System requirements

Minimum Requirements

- PC with Windows 10
- 64-bit processor & operating system
- Intel i5 or AMD 64 FX or later processor
- 5GB of free hard drive space
- 4 GB of free RAM
- Internet connection of 100bps or greater

2.5 General safety information



This section contains instructions regarding safety. Please read carefully.

- All users should read this guide before using the 3D Foot Scanner. This guide should always be available to users.
- Prior to a measurement session, instruct the client how to stand on the 3D Foot Scanner.
- Do not jump on the glass plate. Protect the glass plate from high impacts or sharp objects.
- Do not exceed the maximum specified weight of 200 Kg (440 lbs.).
- Do not stand or sit on the scanner's sides.
- Do not use the 3D Foot Scanner if cables or parts such as the glass plate, steps or handlebar are damaged.
- Do not use a USB connection cable longer than the supplied 1.8m (71 Inches) cable. Use a powered hub or active extension cable in combination with the supplied cable if a longer connection cable is required.
- Always use the supplied USB cable for compliance to the applied standards.
- Heavy device; lift with two persons using the provided straps.
- Install the 3D Foot Scanner level on a solid, level, and non-skid surface.
- Power off the 3D Foot Scanner when not in use or before connecting / disconnecting cables.
- Unplug the power cord when not in use for longer periods.
- Only use the supplied EN 60601-1 compliant AC adapter. Using other power supplies may violate the safety standard and/or could damage the scanner.
- Do not wrap the cord from the AC adapter around the AC adapter. This may damage the cord.
- To reduce the risk of electric shock or damage to the equipment, plug the AC adapter into an AC outlet that is always easily accessible.
- Protect the 3D Foot Scanner cables and connectors from accidental damage. Secure the cables to prevent accidental tripping or entanglement. Do not bend or wrap the cables.
- Protect the 3D Foot Scanner from shocks and vibration.
- Do not place the 3D Foot Scanner adjacent to equipment or power lines which generate strong electromagnetic or electrostatic fields, or in the vicinity of sensitive equipment. Relocate if necessary.
- A minimum distance between the 3D Foot Scanner and sources of reciprocal interference shall be at least 0.25 m.
- Do not operate or store the 3D Foot Scanner outside the specified environmental temperature and humidity range. Do not expose to direct sunlight. Do not expose to moisture.
- The connected PC should be compliant with the appropriate safety standard for medical or non-medical equipment (EN 60601-1 or EN 60950-1).

- Ensure a safe distance of 1.5m between the client and the PC or other equipment not compliant with the EN 60601-1 standard.
- Should the client incur injury due to use or malfunction of the 3D Foot Scanner, providing all precautions are taken, the 3D Foot Scanner is well maintained and used as intended, report such event to the manufacturer.
- The 3D Foot Scanner is not intended to be used in an oxygen rich environment.
- The entire 3D Foot Scanner is designated as a type B applied part.

2.6 Laser safety

- The 3D Foot Scanner uses Class 1 laser light. Do not stare into the laser beam or view directly with optical instruments. Laser light can damage your eyes.
- The 3D Foot Scanner uses four lasers and is classified per EN 60825-1:2014 as a Class 1 laser product.
- The 3D Foot Scanner complies with FDA performance standards for laser products except for deviations pursuant to Laser Notice No. 50, dated June 24, 2007.

2.7 Safety inspections



This section contains instructions regarding safety. Please read carefully.

- On a daily basis, visually inspect the glass plate and housing for damage ensuring maximum safety for the client while being measured.
- On a weekly basis, visually inspect the AC adapter, cables and connections. Do not use the system if any cables are damaged. Replacement cables can be ordered.

2.8 Care of the 3D Foot Scanner

- To ensure client safety, clean and disinfect the glass plate between uses.
- The glass plate and other surfaces can be cleaned and disinfected with a suitable disinfectant or a mild detergent.
- Do not pour or spray the cleaning or disinfectant product directly on the 3D Foot Scanner or glass plate. Use a damp cloth to clean and remove contamination.
- Wipe the surface of the glass plate with the damp cloth, if necessary, wipe the other parts of the 3D Foot Scanner.
- Make sure the glass plate is completely dry before use.
- Do not use solvent based, flammable, aggressive or abrasive cleaning or disinfectant products (such as alcohol, acetone, or ammoniac). Consult the labelling of the products before use.

2.9 Calibration and repair

- The 3D Foot Scanner is calibrated in the factory. A new calibration is required after replacing the laser, optics, camera or other mechanical parts by a qualified and authorized technician or in case these parts are out of alignment due to mishandling, shocks or heavy vibrations.
- There are no user serviceable parts inside the 3D Foot Scanner. Disassembly will void warranty.
- Repairing the 3D Foot Scanner should only be performed by qualified and authorized personnel. Contact the support department for more information.
- Save the original packaging. It can be used to ship the 3D Foot Scanner for repair.

2.10 Limited warranty terms and conditions

- The 3D Foot Scanner (the “Product”) is covered by warranty against defects in materials and workmanship for a period of one (1) year from the date of the original purchase (the “Warranty Period”) when used in accordance with the Installation and User Guide.
- If the Product is determined to be defective during the Warranty Period, HP Inc. will, at its option, (1) repair the Product, (2) exchange the Product with a new Product or refurbished Product that is equivalent to new in performance and reliability.
- Repair or exchange as provided under this warranty is the sole and exclusive remedy of the consumer and HP Inc’s sole and exclusive liability in respect of defects in the Product.
- Customer shall contact Arize support department for any support requests or to initiate the warranty service procedure.
- To the extent permitted by applicable law(s) HP Inc. does not assume any liability for loss of or damage to or corruption of data, for any loss of profit, loss of use of products or functionality, loss of business, loss of contracts, loss of revenues or loss of anticipated savings, increased costs or expenses or for any indirect loss or damage, consequential loss or damage or special loss or damage.

The warranty includes:

- The cost of all parts and labor in the repair or replacement of the Product, following mechanical or electrical breakdown, which are shown to the satisfaction of HP Inc. to be defective due to faulty materials or workmanship.

The warranty excludes:

- Normal wear and tear, including wearing parts.
- Damage to the glass plate.
- Failures due to accidental damage, careless operating, unintended use, use or incorrect installation of incompatible third-party equipment, negligence, handling damage, transit damage, misuse, non-compliance with the supplied instructions, force majeure, natural forces or damage due to other external causes.
- Unsatisfactory performance caused by non-compliance with the minimum system requirements, the use or attachment of any accessories not produced or authorized by HP Inc.
- Repairs, alterations or disassembly carried out by unauthorized parties.
- Products damaged during transit to HP Inc. due to insufficient or improper packaging.
- Software.

3. UNPACKING AND INSTALLATION

 **Caution: Heavy device, lift with two persons!**

- 1 • Cut the straps to release the accessories box from the scanner box.
- Remove the accessories box and set aside.

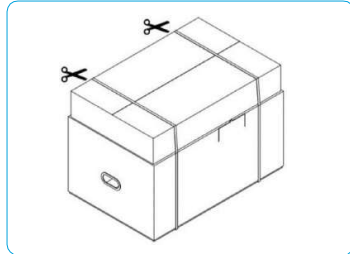

- 2 • The scanner box consists of an *upper* and *bottom* half.
- Remove the plastic handles on front and rear side. This will remove the lock between the *upper* and *bottom* parts.
- Lift the *upper* cardboard off the box.

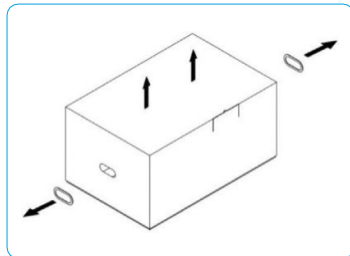

- 3 • The four sides of the *bottom* cardboard will fold down allowing full access to the scanner.
- Remove the protective parts from the top corners and top.

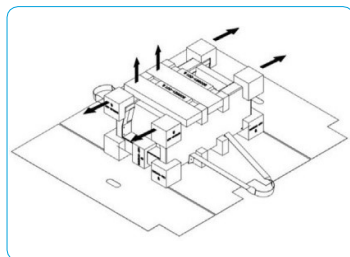

- 4 • Lift the scanner with two persons using the attached straps.
- Place the scanner at the point of use.
- Do not place under direct lighting or sunlight.

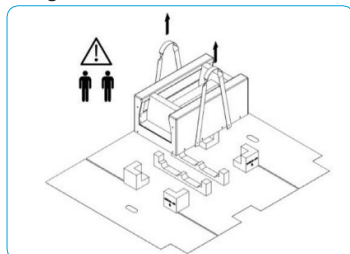

- 5 • Remove the Allen key from the lifting strap.
- Use the Allen key to remove the four hex screws and washers that hold the lifting straps in place.
- Store the straps and screws for future use.
- Remove the protective parts inside the scanner.

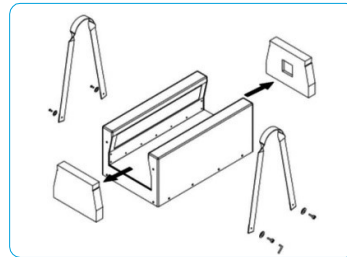

- 6 • The connections and power switch are on the rear of the scanner. Orient the front of the scanner to face the client.

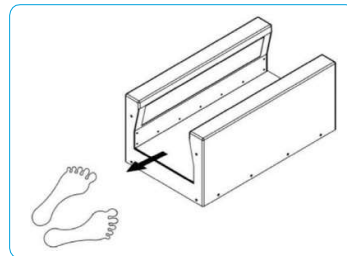

- 7 • Make sure the scanner is level on a solid floor.
- Adjust the four feet to level the scanner by turning them clockwise or counter clockwise.

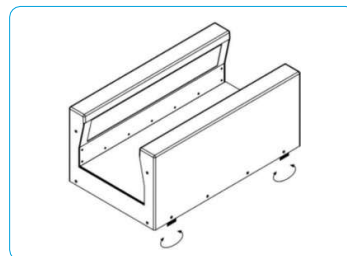

- 8 • Open the accessories box and remove the parts.

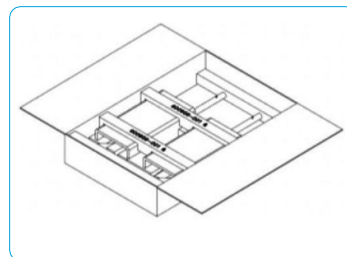

3. UNPACKING AND INSTALLATION

- 9 • Secure the two extension rods for the handlebar to the back of the scanner using the four screws and Allen key supplied with the four protection pads on the rods positioned towards the scanner.

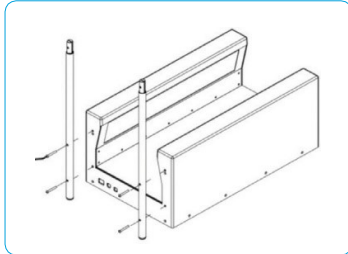

- 10 • Slide the handlebar over the extension rods until the hex screws are visible through the holes in the handlebar.
 • Turn the hex screws slightly clockwise or counter clockwise if the rods cannot be fully inserted in the handle bar.
 • Turn the hex screws clockwise to secure the extension rods.

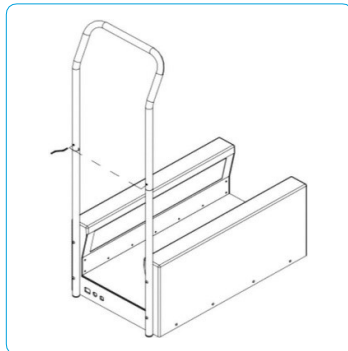

- 11 • Place the steps next to the scanner, align the mounting holes with the holes at the sides of the scanner, and secure them using the four knobs. Adjust the steps until they are supported by the floor, fasten the knobs.

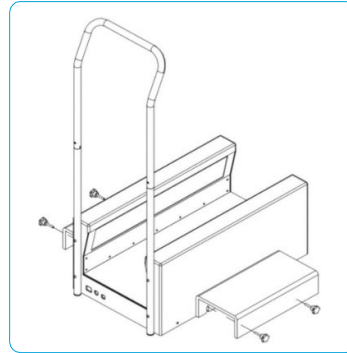



4. SOFTWARE INSTALLATION

 **Caution:** Do not connect the 3D Laser Foot Scanner to the USB port of the PC until the software is installed.

Please refer to the software guide provided with the application being used.

Download “Scanner Software Installer” from ArizeClinical.com

Step 1: On the “Setup” tab click “Scanner Software Installer” to download software for your 3D Laser Scanner

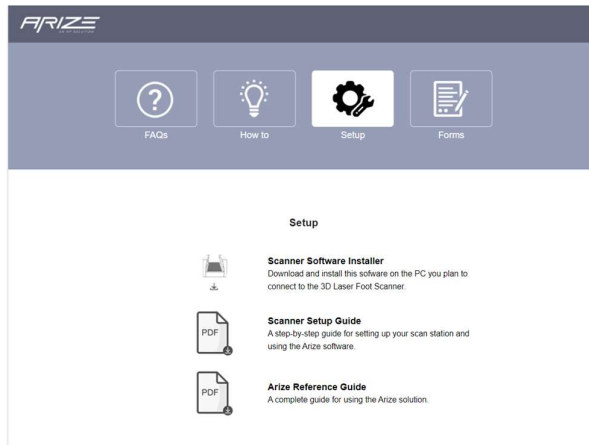

Step 2: Once the download is complete click on the file to begin the installation process

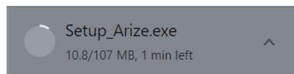

Step 3: Unpack the software by following prompts

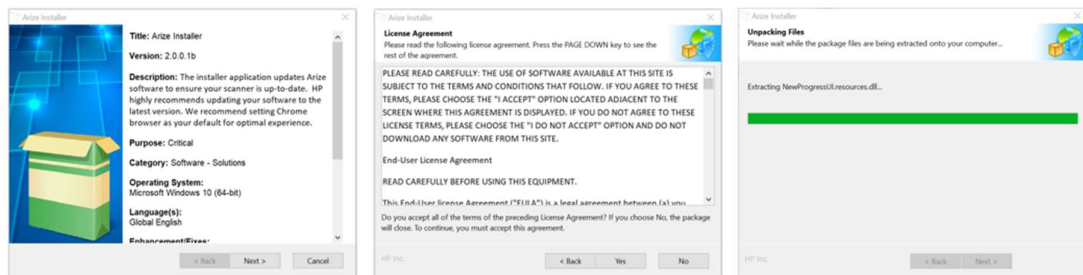

Step 4: Complete setup by clicking Continue. It will take about 5 minutes to install your software.

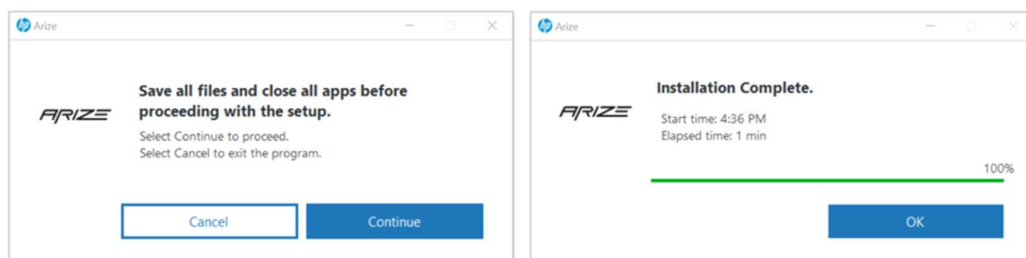

5. CONNECTING THE SCANNER

Once the software has been successfully installed, you are ready to connect the 3D Laser Foot Scanner.

- 1 • Verify if the power switch is in the OFF position (Marked O).

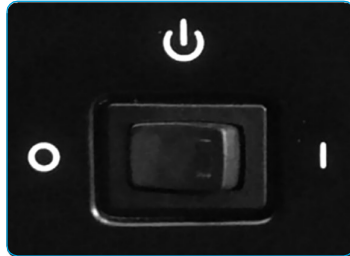

- 2 • Connect the AC adapter to the 3D Laser Foot Scanner.

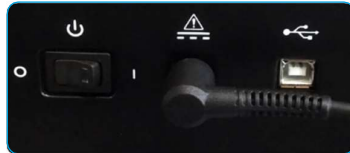

- 3 • Connect the power cord to the AC adapter and then plug it into the AC outlet.



- 4 • Connect The 3D Laser Foot Scanner to your PC using the supplied USB cable. Connect the USB-B plug side of the cable (square plug) to the USB connector on the 3D Laser Foot Scanner.
 - Match the orientation of the plug and connector, align the beveled edges of the plug with the beveled edges of the connector.

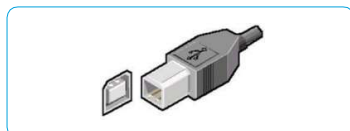

- 5 • Connect the USB-A plug side of the cable (flat rectangular plug) to a free USB port on your PC.
 - Match the orientation of plug and connector.

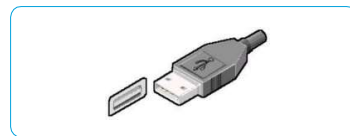

- 6 • When the hardware setup is completed, switch on the 3D Laser Foot Scanner by switching the power switch to the ON position (Marked I). The green power LED inside the switch will light up.



6. START THE SOFTWARE

Make sure your scanner is powered on and connected to your PC. Please refer to the software guide for using the online web-based application.

Visit: ArizeClinical.com and click "Client Sign In"

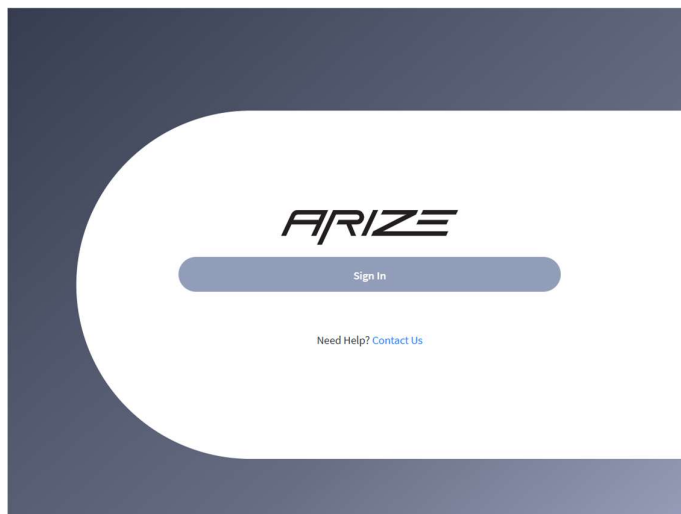

7. YOUR FIRST MEASUREMENT

Once you have installed the software and set up the 3D Laser Foot Scanner, you are ready to take your first measurement. You can scan semi-weighted or weighted. Before scanning a patient make sure your installation is working by doing a test scan.

- **Semi-Weighted Scan (shown)**

Let the patient sit on a chair and position their foot at a 90-degree angle onto the glass plate of the scanner.

- **Weighted Scan**

Let the patient step carefully onto the glass plate of the scanner with either left or right foot, the other foot on the support step. Have the client use the handlebar for balance and support.

- Roughly position the center of the foot in the center of the three white markers to obtain the best scan result. Foot should maintain a 90-degree stance while the scan is run.

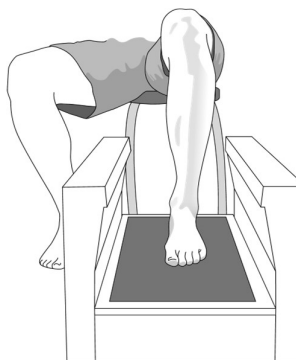

Refer to the software instructions for information on how to take a measurement.

8. TROUBLESHOOTING

Once you have installed the software and set up the 3D Laser Foot Scanner, you are ready to take your first measurement.

The power LED does not light up

- ✓ Check if the power switch is in the **ON** position (marked I).
- ✓ Check if the AC adapter is plugged into the scanner.
- ✓ Check if the power cord is plugged in to the AC adapter and the AC outlet.

The PC does not recognize the scanner

- ✓ Check if the USB cable is plugged in at the scanner and the PC.
- ✓ Reinstall the software.

9. SYSTEM SPECIFICATIONS

9.1 Model 28BA0101

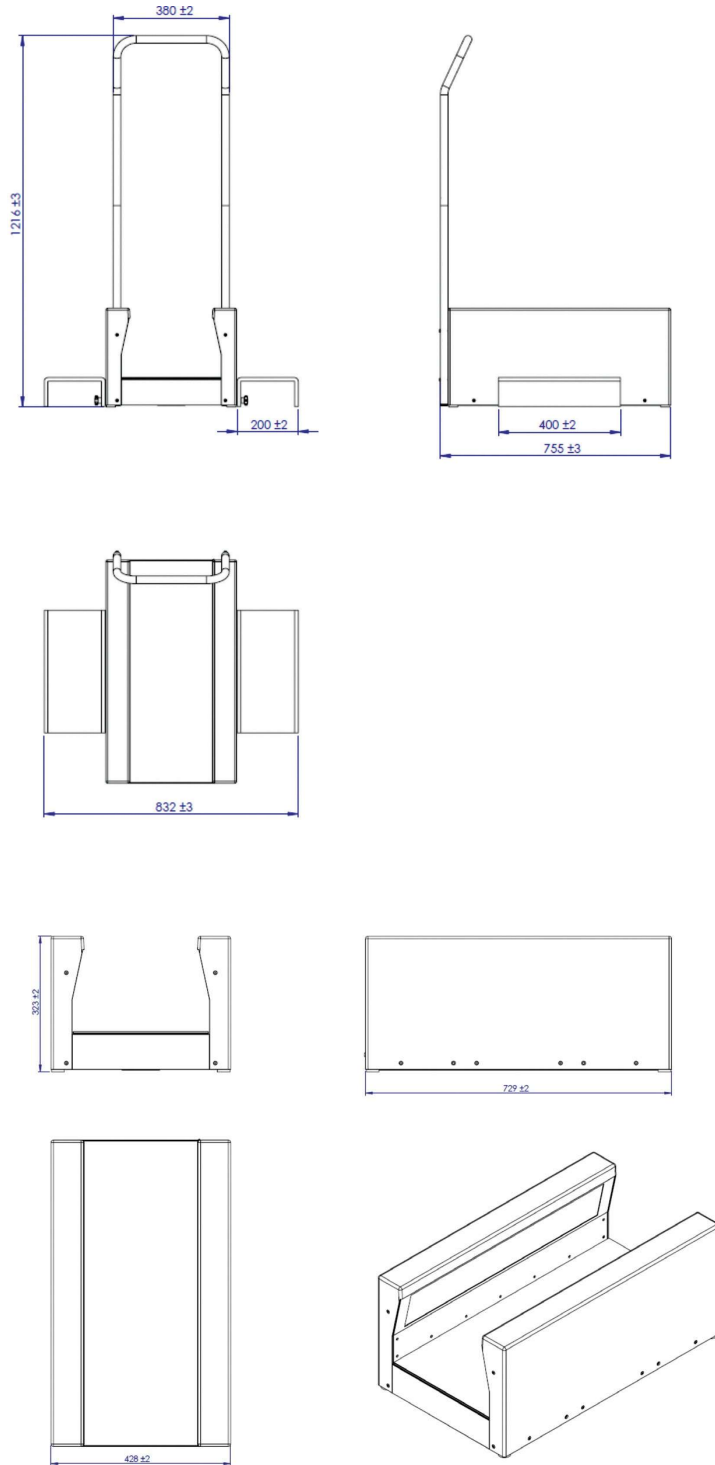

9. SYSTEM SPECIFICATIONS

9.1 Model 28BA0101

Dimensions (scanner body) (L x W x H):	729 x 428 x 323 mm (28.70 x 16.85 x 12.72 Inches)
Dimensions (with handlebar and steps) (L x W x H):	755 x 832 x 1216 mm (29.72 x 32.75 x 47.87 Inches)
Weight (with handlebar):	26 Kg (57.32 lbs.)
Scanning area (L x W x H):	400 x 200 x 180 mm ±5 mm (15.75 x 7.87 x 7.09 Inches ±0.197 Inches)
Measurement standard deviation:	0.5mm 0.02 Inches
Scan time:	5-15 seconds
Radiation output and standards information: Laser class: Max output of laser radiation: Emitted wavelength(s): Standard(s):	4 lasers Class I 1.5 mW 650nm IEC 60825-1:2014 (Third Edition)
Camera type:	1 color camera: SENSOR IMAGE VGA RGB color 48-CLCC 8 monochrome cameras: SENSOR IMAGE VGA mono 48-CLCC
Operating temperature range:	+10 °C .. +35 °C (+50 °F .. +95 °F)
Storage temperature range:	+5 °C .. +50 °C (+41 °F .. +122 °F)
Relative humidity:	20% .. 80% non-condensing
Protection class:	I
IP code:	IP40
I/O:	1x USB 2.0 (1.8m USB cable A–B)
Supply voltage (AC adapter):	100 – 250 V AC 50-60 Hz (to AC adapter)
Supply voltage (DC):	19V DC (from AC adapter)
Power consumption (AC adapter):	<0.2 W standby 12 W non scanning 24 W scanning
HP part number:	4C1T0A
Regulatory model number:	28BA0101

9. SYSTEM SPECIFICATIONS

9.1 Model 28BA0101

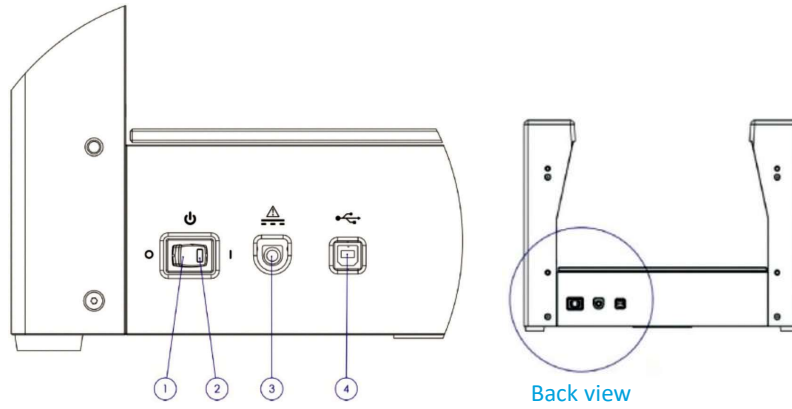

1. Power switch:	to switch the 3D Laser Foot Scanner on or off
2. Power LED:	to indicate that the 3D Laser Foot Scanner is powered on
3. Power:	connect the supplied AC adapter, do not use any other AC adapter
4. USB:	connect the USB-B end of the USB cable, connect the USB-A end of the USB cable to the PC